



Steel Large Diameter O.D. Machines

ADVANTAGES

- Belt-driven
- Both radial and axial feeds
- Manual and automatic feeds
- All types of RMS finishes
- Tool-holder for 1/2" tool bits
- Compound swivels to machine all angles from 0 to 90 degrees
- Rigid construction to maximize performance
- Adjustable jaws for fast 4-jaw set up
- Back-facing attachments available
- All rotating parts concealed behind solid cover
- Pneumatic and hydraulic motors
- Lifting cables and swivel eyes provided



APPLICATIONS

- Refineries
- Chemical Plants
- Shipyards
- Manufacturing Facilities
- Petrochemical
- Oil and Gas
- Raised Face Flanges
- Ring Type Joint
- Grayloc Flanges
- All RMS Finishes

PRODUCT DESCRIPTION

Superior's Steel O.D. Mount Flange Facing Machines were designed to cover a wide range of applications with operator efficiency built into the overall design, rigging, and packaging of each unit we provide. Superior's machines are belt-driven with adjustable cam bearings, driven with a pneumatic motor allowing them to be used in more precise applications. The slide and compound are a ball rail design which produces a very smooth and precise travel. The compound can swivel to any angle off vertical, which allows these Flange Facers to machine all types of gasket surfaces.

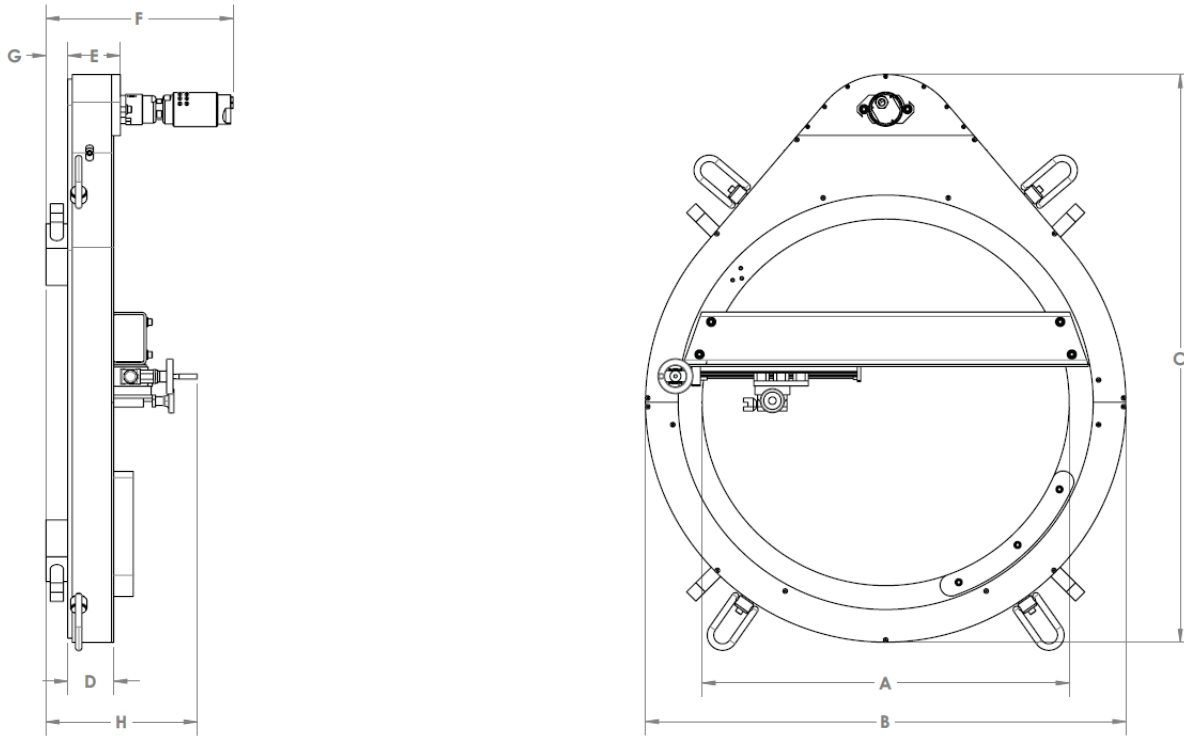

Description	Callout	ODF-21	ODF-30	ODF-32	ODF-40	ODF-42	ODF-52	ODF-62	ODF-72	ODF-82	ODF-102
Inside Diameter	A	21.125"	30"	32.125"	40"	42.125"	52.125"	62.125"	72.125"	82.125"	102.125"
Outside Diameter	B	34.5"	43.375"	45.125"	54.625"	54.625"	66.75"	75.25"	85.375"	95.250"	115.625"
Drive Projection	C	41.5"	57"	67.25"	67.25"	67.25"	79.5"	88.25"	97"	108.25"	128.75"
Height of Machine	D	4.375"	5.25"	5.25"	5.25"	5.25"	5.25"	5.25"	5.25"	5.25"	5.5"
Height of Drive Plate	E	5"	5.75"	5.75"	5.75"	5.75"	6.25"	6.25"	6.25"	6.25"	6.5"
Height of Motor	F	20"	20"	20.75"	20.75"	20.75"	21.25"	21.25"	21.25"	21.25"	21.75"
Height of Jaws	G	3.5"	3.5"	3.5"	3.5"	3.5"	3.5"	3.5"	3.5"	3.5"	3.5"
Height of Handle	H	13.5"	13.5"	13.5"	13.5"	13.5"	13.5"	13.5"	13.5"	13.5"	14"
Thickness of Base		1.625"	2"	2"	2"	2"	2"	2"	2"	2"	2"
Bridge Size		4" X 5"	4" X 6"	4" X 6"	4" X 6"	4" X 6"	4" X 8"	4" X 8"	4" X 8"	4" X 8"	4" X 8"
Number of Jaws		4	4	4	4	4	8	8	8	8	8
Weight of Machine		725 lbs	1050 lbs	1125 lbs	1400 lbs	1475 lbs	1525 lbs	1725 lbs	1950 lbs	3020 lbs	4210 lbs
Shipping Weight		725 lbs	1050 lbs	1125 lbs	1400 lbs	1475 lbs	1525 lbs	1725 lbs	1950 lbs	4540 lbs	6320 lbs
Shipping Dimensions		34.5" x 41.5" x 20"	43.375" x 57" x 20"	45.125" x 67.25" x 20.75"	54.625" x 67.25" x 20.75"	54.625" x 67.25" x 20.75"	66.75" x 79.5" x 21.25"	75.25" x 88.25" x 21.25"	85.375" x 97" x 21.25"	114" x 85" x 85"	140" x 90" x 90"

**Recommended air supply for proper performance = 3/4" diameter line with 70 cfm at 90 psi.



833.447.3777



info@sprtool.com



sprtool.com

Follow us on social media:

